

# Konijnenhok Sanne

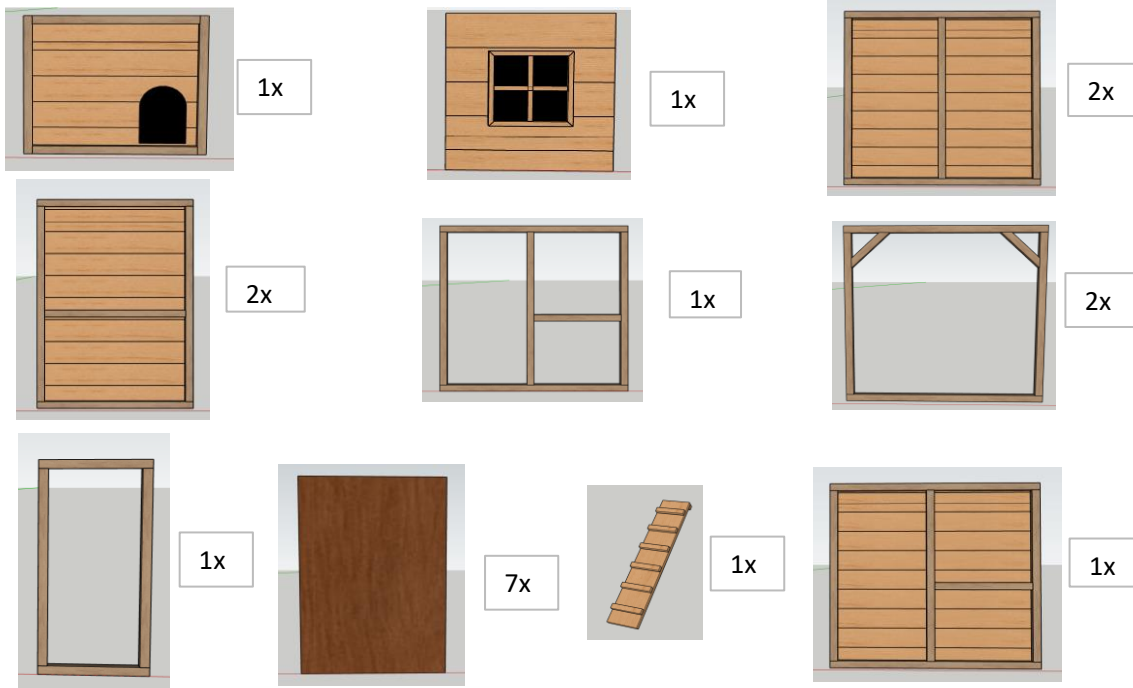

## Benodigheden:

- Schroefmachine
- Rolmaat
- Bit pz2
- Bit pz1
- Boortje 4mm (is meegeleverd)
- \*ALLE SCHROEVEN VOORBOREN\*



**Dakbedekking**  
-3x 352x45cm



### Rabat

- 3x 79cm - 30° - 30°
- 3x 48cm - 30° - 30°

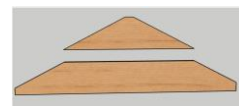

### Lat

- 2x 71,4cm (30x16mm)
- 2x 34cm (65x16mm)
- 4x daktrim 60cm



### Balk 44x44mm

- 4x 79cm
- 1x 57cm
- 14x 51,6cm - 30° - 60°

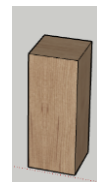

### Overige

- 1x Legbak
- 4x Geheng 20cm
- 2x schuifslot

- 44x Schroef 70mm
- 50x Schroef 40mm
- 102x Schroef 30mm
- 16x Schroef 20mm

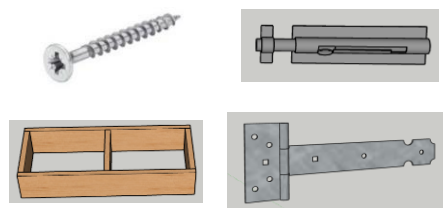

**1.**

2x Lat 30x16mm - 2x 71,4cm  
6x Schroef 30mm

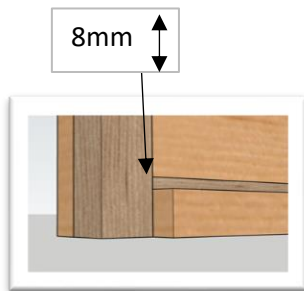

**2.**

3x Schroef 70mm



Onder/bovenaanzicht

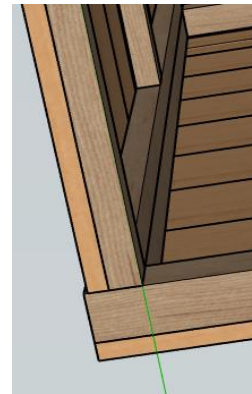

**3.**

3x Schroef 70mm



**4.**

3x Schroef 70mm



**5.**

3x Schroef 70mm

Onder/bovenaanzicht

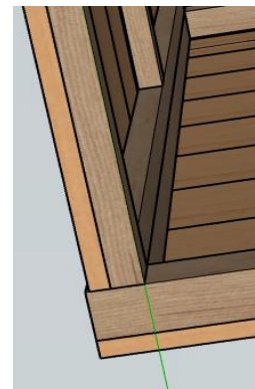

**6.**

3x Schroef 70mm

Onder/bovenaanzicht

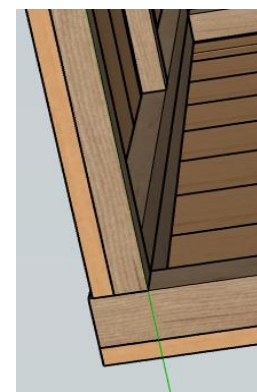
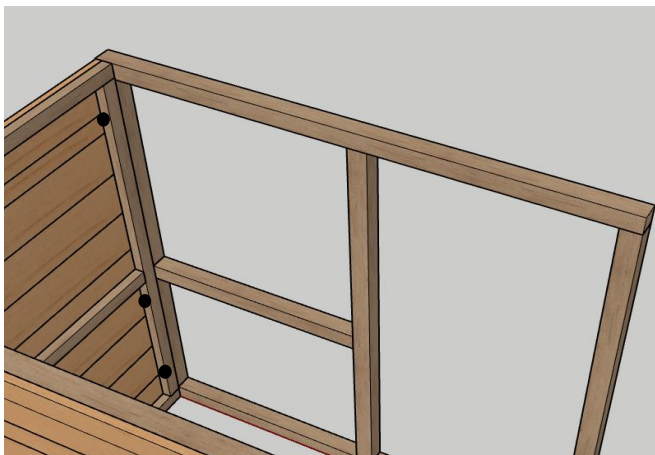

**7.**

4x Schroef 70mm

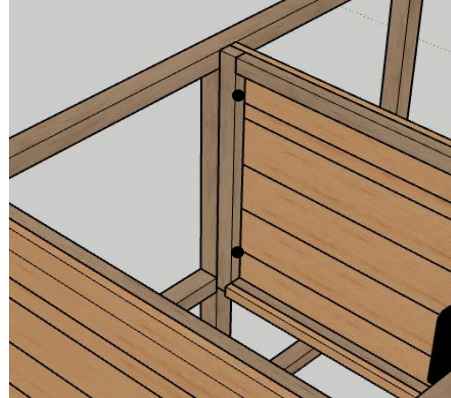
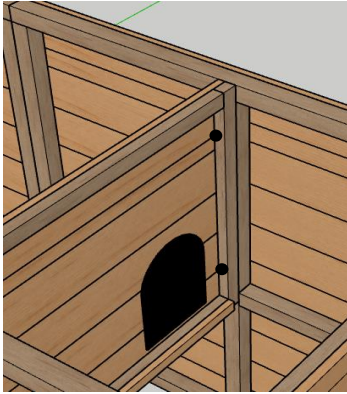

**8.**

3x Schroef 70mm



**9.**

6x Schroef 70mm

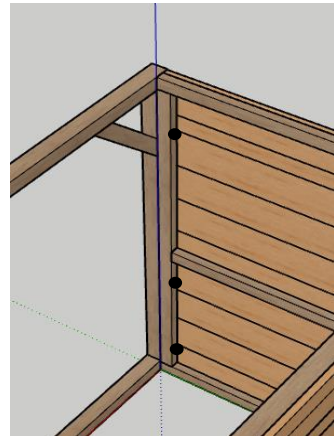

**10.**

1x betonplex 55x85cm

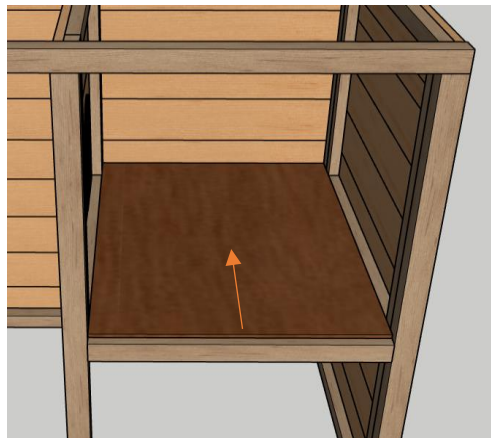

**11.**

4x geheng 20cm  
12x Schroef 30mm

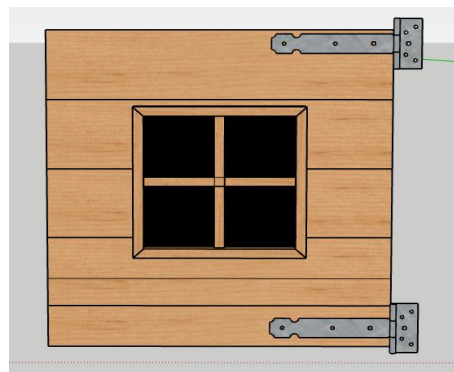
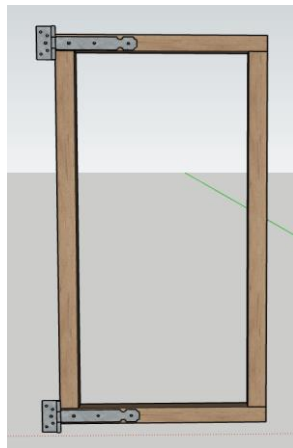

**12.**

2x Schuifslot  
8x Schroef 40mm  
16x Schroef 20mm



**13.**

2x Lat 65x16mm - 34cm  
1x Balk 44x44mm - 57cm  
1x Legbak  
12x Schroef 30mm

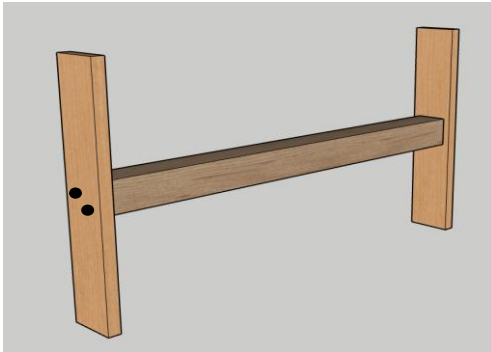

1.



2.

**14.**

4x Balk 44x44mm - 79cm  
16x Schroef 70mm

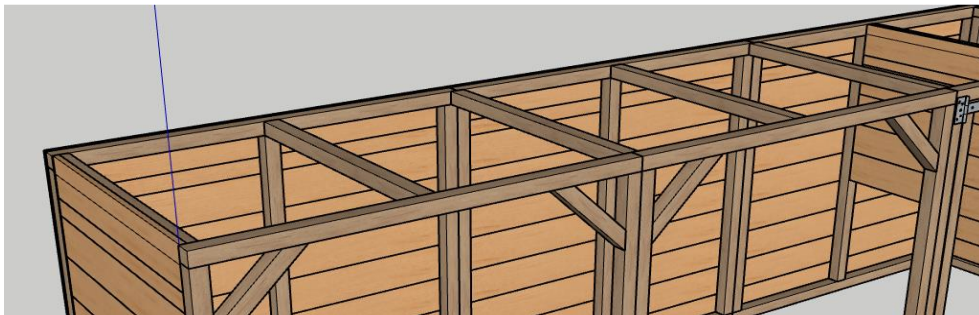

**15.**

14x Balk 44x44mm - 51,6cm 30\* - 60\*  
42x Schroef 40mm

1.

19mm ↔

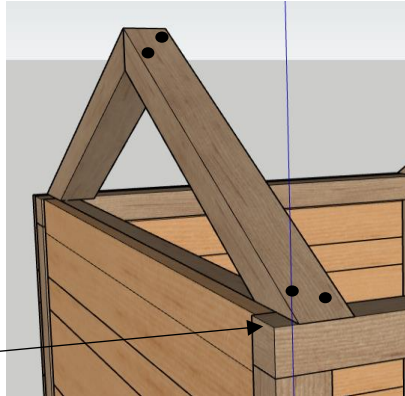

2.

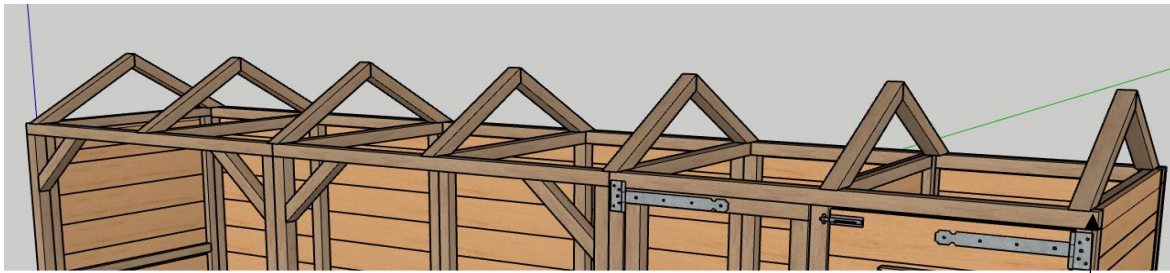

19mm ↔

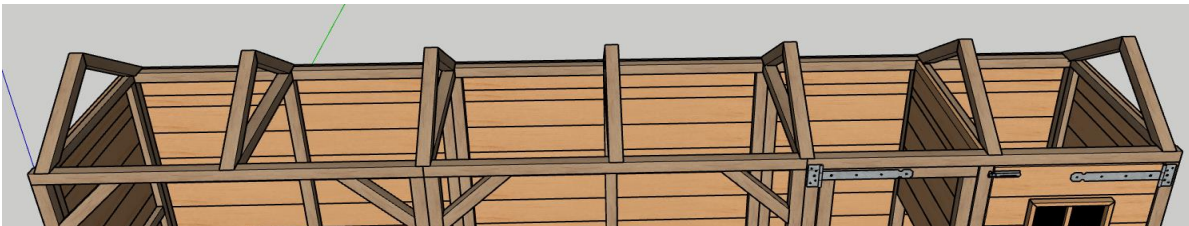

**16.**

3x Rabat 79cm - 30\* -30\*  
3x Rabat 48cm - 30\* -30\*

**1.**

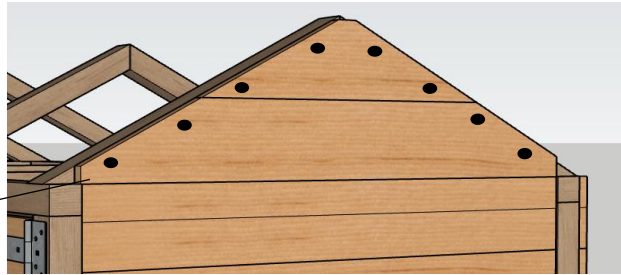

**2.**



**17.**

4x Betonplex 116x55cm  
2x Betonplex 120x55cm  
32x Schroef 30mm

22mm ↔

22mm ↔





**18.**

3x dakbedekking 352x45cm



Verwijder de folie van de onderzijde en verdeel hierna de dakbedekking over de betonplex platen.

11cm



1.



2.

**19.**

4x Daktrim 60cm  
16x Schroef 30mm

